

# *Make Your Life Bright*

LED Lighting Solutions | FZ Group

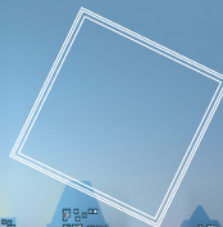



### About FZTech, Inc.

A Taiwan-based supplier dedicated to bringing ease of life to customers, by designing & developing high-performance technology products. With high-quality and creative design, the product range includes PC, LED lighting, consumer electronics product applications and accessories. FZtech offers total metal/thermal solutions and provides OEM/ODM services to various industry leading companies. For more information, visit FZtech online at [www.FZtech.com.tw](http://www.FZtech.com.tw)



### About FZLED

FZLED is a Taiwan-based manufacturer and innovative designer of high-performance LED lighting products. As a sub-division of FZtech Inc., FZLED's products have superior mechanical and thermal design, utilizing the expertise of FZtech. Committed to excellence, FZLED follows a strict TQC for the entire manufacturing process, and conducts R&D projects continuously in an effort to create LED lighting solutions that offer lightweight, high-quality, environmentally-friendly, innovative, and thermally-optimized products to customers. For more information visit FZLED online at [www.FZLED.com.tw](http://www.FZLED.com.tw).

# Content

## • MR16 Spotlight

- 01 FZL-MR16-03 Series: 3W  
FZL-MR16-04 Series: 3W
- 02 FZL-MR16-04 Series: 5W  
FZL-MR16-05 Series: 5W

## • GU60 Bulb

- 03 FZL-GU60-00 Series: 9W / 12W

## • PAR20 Spotlight

- 03 FZL-PAR20-00 Series: 7W

## • PAR30 Spotlight

- 04 FZL-PAR30-02 Series: 12W  
FZL-PAR30-03 Series: 12W

## • PAR38 Spotlight

- 05 FZL-PAR38-02 Series: 22W  
FZL-PAR38-03 Series: 22W

## • Downlight

- 06 FZL-DL02-00 Series: 5W  
FZL-DL03-00 Series: 8W
- 07 FZL-DL04-00 Series: 9W  
FZL-DL06-00 Series: 12W
- 08 FZL-DL08-00 Series: 22W  
FZL-DL10-00 Series: 28W
- 09 FZL-DL06-01 Series: 12W  
FZL-DL08-01 Series: 22W

## • Panel Light

- 10 FZL-PL30-00-22 Series: 22W (300 x 300 mm)  
FZL-PL60-00-52 Series: 52W (600 x 600 mm)  
FZL-PL120-00-52 Series: 52W (1200 x 300 mm)
- 11 FZL-PL30-01-28 Series: 28W (300 x 300 mm)  
FZL-PL60-01-42 Series: 42W (600 x 600 mm)  
FZL-PL60-01-52 Series: 52W (600 x 600 mm)
- 12 FZL-PL120-01-42 Series: 42W (1200 x 300 mm)  
FZL-PL120-01-52 Series: 52W (1200 x 300 mm)

## • T8 Tube Light

- 13 FZL-T8-05L Series: 10W / 18W / 20W
- 14 FZL-T8-06L Series: 12W / 22W / 28W / 44W
- 15 FZL-T8-07 Series: 6W / 12W / 22W

## • FloodLight

- 16 FZL-FL Series: 12W / 35W / 60W / 110W

## • LED Torch

- 17 FZL-1310 Bike Torch / FZL-2110 Portable Torch  
FZL-2200 Hiking Torch / FZL-2301 Security Torch
- 18 FZL-2300 Security Torch / FZL-2500 Water Proof Torch  
FZL-4200 Head Light / FZL-3201 Flexible Work Light
- 19 FZL-5100 Night Light Torch

## • Aqua Light

- 19 FZL-6100

# MR16 Spotlight

3W

## FZL-MR16-03 Series

- Luminous Flux (lm): 120 (±10%) with 3000K / 160 (±10%) with 6000K
- Power Consumption (W): 3
- LED: Cree (1 pc)
- CCT (K): 3000 (WW) / 6000 (CW)
- Lifetime (hrs): >35000
- Beam Angle: 10° / 25° / 40° / 60°
- Dimmable: Non - dimmable

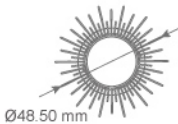

Model	FZL-MR16-03-WW-03 / FZL-MR16-03-CW-03							
Input Voltage (V)	DC / AC 12V		AC 90 – 240V					
Socket	GU5.3	GU10	E11	E14	E17	E26	E27	B22
Net Weight (kgs)	0.023 (±10%)	0.038 (±10%)	0.045 (±10%)	0.045 (±10%)	0.045 (±10%)	0.045 (±10%)	0.045 (±10%)	0.045 (±10%)

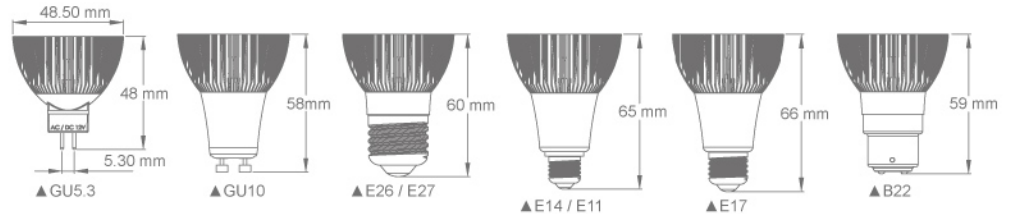

3W

## FZL-MR16-04 Series

- Luminous Flux (lm): 180 (±10%) with 3000K / 230 (±10%) with 6000K
- Power Consumption (W): 3
- LED: Cree (3 pcs)
- CCT (K): 3000 (WW) / 6000 (CW)
- Lifetime (hrs): >35000
- Beam Angle: 15° / 25° / 40°



Model	FZL-MR16-04-WW-03 / FZL-MR16-04-CW-03							
Input Voltage (V)	DC / AC 12V		AC 90 – 240V					
Socket	GU5.3	GU10	E11	E14	E17	E26	E27	B22
Net Weight (kgs)	0.025 (±10%)	0.040 (±10%)	0.048 (±10%)	0.048 (±10%)	0.048 (±10%)	0.048 (±10%)	0.048 (±10%)	0.048 (±10%)

Model	FZL-MR16-04-WW-03TDH / FZL-MR16-04-CW-03TDH							
Input Voltage (V)	DC / AC 12V		AC 220 – 240 V (TriAC dimmable)					
Socket	GU5.3	GU10	E11	E14	E17	E26	E27	B22
Net Weight (kgs)	0.025 (±10%)	0.040 (±10%)	0.048 (±10%)	0.048 (±10%)	0.048 (±10%)	0.048 (±10%)	0.048 (±10%)	0.048 (±10%)

Model	FZL-MR16-04-WW-03TDL / FZL-MR16-04-CW-03TDL							
Input Voltage (V)	DC / AC 12V		AC 100 – 120V (TriAC dimmable)					
Socket	GU5.3	GU10	E11	E14	E17	E26	E27	B22
Net Weight (kgs)	0.025 (±10%)	0.040 (±10%)	0.048 (±10%)	0.048 (±10%)	0.048 (±10%)	0.048 (±10%)	0.048 (±10%)	0.048 (±10%)

# MR16 Spotlight

5W

## FZL-MR16-04 Series

- Luminous Flux (lm): 250 (±10%) with 3000K / 300 (±10%) with 6000K
- Power Consumption (W): 5
- LED: Cree (3 pcs)
- CCT (K): 3000 (WW) / 6000 (CW)
- Lifetime (hrs): >35000
- Beam Angle: 15° / 25° / 40°



Model	FZL-MR16-04-WW-05 / FZL-MR16-04-CW-05							
Input Voltage (V)	DC / AC 12V		AC 90 – 264V					
Socket	GU5.3	GU10	E11	E14	E17	E26	E27	B22
Net Weight (kgs)	0.025 (±10%)	0.040 (±10%)	0.048 (±10%)	0.048 (±10%)	0.048 (±10%)	0.048 (±10%)	0.048 (±10%)	0.048 (±10%)
Model	FZL-MR16-04-WW-05TDH / FZL-MR16-04-CW-05TDH							
Input Voltage (V)	DC / AC 12V		AC 220 – 240 V			TriAC dimmable		
Socket	GU5.3	GU10	E11	E14	E17	E26	E27	B22
Net Weight (kgs)	0.025 (±10%)	0.040 (±10%)	0.048 (±10%)	0.048 (±10%)	0.048 (±10%)	0.048 (±10%)	0.048 (±10%)	0.048 (±10%)
Model	FZL-MR16-04-WW-05TDL / FZL-MR16-04-CW-05TDL							
Input Voltage (V)	DC / AC 12V		AC 100 – 120V			TriAC dimmable		
Socket	GU5.3	GU10	E11	E14	E17	E26	E27	B22
Net Weight (kgs)	0.025 (±10%)	0.040 (±10%)	0.048 (±10%)	0.048 (±10%)	0.048 (±10%)	0.048 (±10%)	0.048 (±10%)	0.048 (±10%)

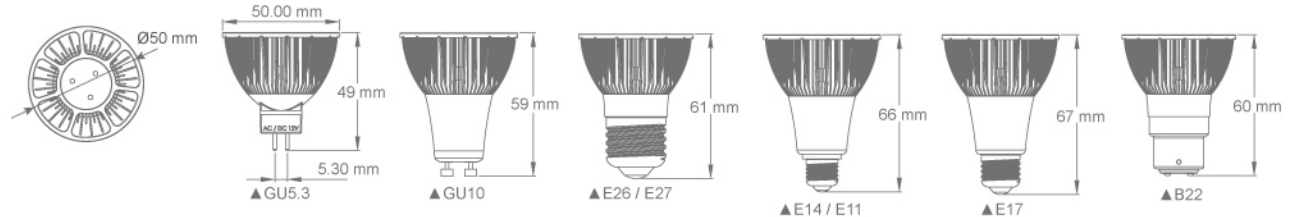

5W

## FZL-MR16-05 Series

- Luminous Flux (lm): 380 (±10%) with 3000K / 450 (±10%) with 6000K
- Power Consumption (W): 5
- LED: Cree (4 pcs)
- CCT (K): 3000 (WW) / 6000 (CW)
- Lifetime (hrs): >35000
- Beam Angle: 30° / 45°
- Dimmable: Non - dimmable



Model	FZL-MR16-05-WW-05 / FZL-MR16-05-CW-05
Input Voltage (V)	DC / AC 12V
Socket	GU5.3
Net Weight (kgs)	0.035 (±10%)

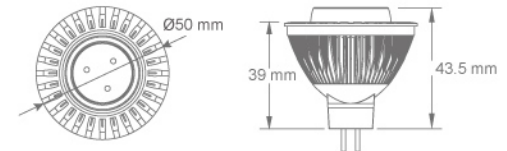

# GU60 Bulb

9W

## FZL-GU60-00 Series

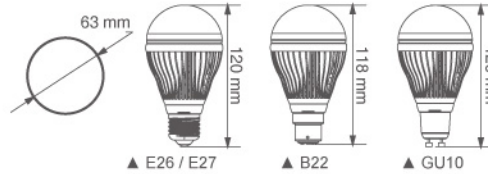

- Luminous Flux (lm): 500 (±10%) with 3000K / 600 (±10%) with 6000K
- Power Consumption (W): 8.2
- LED: Samsung
- CCT (K): 3000K (WW) / 6000K (CW)
- Lifetime (hrs): >35000
- Beam Angle: 120°
- Socket: B22 / E26/ E27 / GU10
- Net Weight (kgs): 0.150 (±10%)



Model	FZL-GU60-00-WW-09 FZL-GU60-00-CW-09	FZL-GU60-00-WW-09TDH FZL-GU60-00-CW-09TDH	FZL-GU60-00-WW-09TDL FZL-GU60-00-CW-09TDL
Input Voltage (V)	AC 90 – 240V (Non-dimmable)	AC 220 – 240V (TriAC dimmable)	AC 100 – 120V (TriAC dimmable)

12W

## FZL-GU60-02 Series

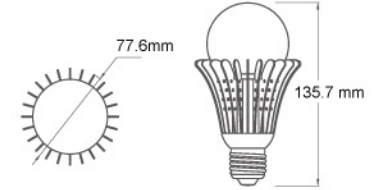

- Luminous Flux (lm): 910 (±10%) with 3000K / 1080 (±10%) with 6000K
- Power Consumption (W): 12
- LED: LEXTAR SMD
- CCT (K): 3000K (WW) / 6000K (CW)
- Lifetime (hrs): >35000
- Beam Angle: 270°
- Socket: E26/ E27
- Net Weight (kgs): 0.115 (±10%)



Model	FZL-GU60-02-WW-12 FZL-GU60-02-CW-12
Input Voltage (V)	AC 110 – 240V (Non-dimmable)

# PAR20 Spotlight

7W

- Luminous Flux (lm): 300 (±10%) with 3000K / 400 (±10%) with 6000K
- Power Consumption (W): 7
- LED: Samsung
- CCT (K): 3000 (WW) / 6000 (CW)
- Lifetime (hrs): >35000
- Beam Angle: 55° / 120°
- Socket: B22 / E26 / E27 / GU10
- Net Weight (kgs): 0.115 (±10%)

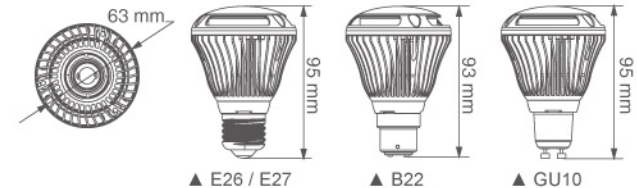

Model	FZL-PAR20-00-WW-07 / FZL-PAR20-00-CW-07	FZL-PAR20-00-WW-07TDH / FZL-PAR20-00-WW-07TDL	FZL-PAR20-00-WW-07TDL / FZL-PAR20-00-WW-07TDL
Input Voltage (V)	AC 100 – 264V (Non-dimmable)	AC 220 – 240V (TriAC dimmable)	AC 100 – 120V (TriAC dimmable)

# PAR30 Spotlight

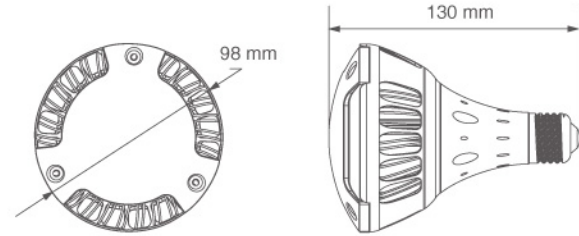

12W

## FZL-PAR30-02 Series

- Luminous Flux (lm): 550 (±10%) with 3000K / 700 (±10%) with 6000K
- Power Consumption (W): 12
- LED: Samsung
- CCT (K): 3000 (WW) / 6000 (CW)
- Lifetime (hrs): >35000
- Beam Angle: Clear Cover – 25° / 40° / 60°  
Frosted cover – 120°
- Socket: E26 / E27
- Net Weight (kgs): 0.250 (±10%)
- Switching Dimmable Function (4 steps: 100%/ 50%/ 25%/ 12%)

<b>Model</b>	FZL-PAR30-02-WW-12 / FZL-PAR30-02-CW-12	FZL-PAR30-02-WW-12SD / FZL-PAR30-02-CW-12SD
<b>Input Voltage (V)</b>	AC 90 – 264V (Non-dimmable)	AC 90 – 264V (Switching Dimmable)
<b>Model</b>	FZL-PAR30-02-WW-12TDH / FZL-PAR30-02-CW-12TDH	FZL-PAR30-02-WW-12TDL / FZL-PAR30-02-CW-12TDL
<b>Input Voltage (V)</b>	AC 220 – 240V (TriAC dimmable)	AC 100 – 120V (TriAC dimmable)

12W

## FZL-PAR30-03 Series

- Luminous Flux (lm): 750 (±10%) with 3000K / 850 (±10%) with 6000K
- Power Consumption (W): 12
- LED: Cree
- CCT (K): 3000 (WW) / 6000 (CW)
- Lifetime (hrs): >35000
- Beam Angle: Clear Cover – 25° / 40° / 60°  
Frosted cover – 120°
- Socket: E26 / E27
- Net Weight (kgs): 0.250 (±10%)
- Switching Dimmable Function (4 steps: 100%/ 50%/ 25%/ 12%)

<b>Model</b>	FZL-PAR30-03-WW-12 / FZL-PAR30-03-CW-12	FZL-PAR30-03-WW-12SD / FZL-PAR30-03-CW-12SD
<b>Input Voltage (V)</b>	AC 90 – 264V (Non-dimmable)	AC 90 – 264V (Switching Dimmable)
<b>Model</b>	FZL-PAR30-03-WW-12TDH / FZL-PAR30-03-CW-12TDH	FZL-PAR30-03-WW-12TDL / FZL-PAR30-03-CW-12TDL
<b>Input Voltage (V)</b>	AC 220 – 240V (TriAC dimmable)	AC 100 – 120V (TriAC dimmable)

# PAR38 Spotlight

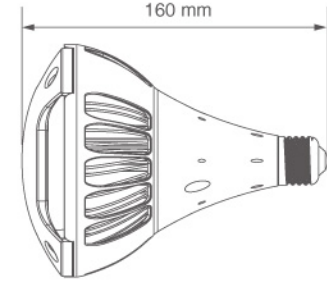
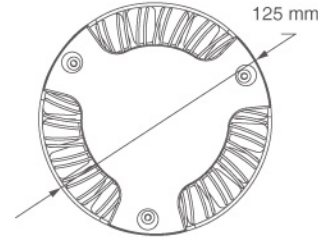

## FZL-PAR38-02 Series

22W

- Luminous Flux (lm): 1200 (±10%) with 3000K / 1400 (±10%) with 6000K
- Power Consumption (W): 22
- LED: Samsung
- CCT (K): 3000K (WW) / 6000K (CW)
- Lifetime (hrs): >35000
- Beam Angle: Clear Cover – 25° / 40° / 60°  
Frosted cover – 120°
- Socket: E26 / E27
- Net Weight (kgs): 0.505 (±10%)
- Switching Dimmable Function  
(4 steps: 100%/ 50%/ 25%/ 12%)

<b>Model</b>	FZL-PAR38-02-WW-22 / FZL-PAR38-02-CW-22	FZL-PAR38-02-WW-22SD / FZL-PAR38-02-CW-22SD
<b>Input Voltage (V)</b>	AC 90 – 264V (Non-dimmable)	AC 90 – 264V (Switching Dimmable)
<b>Model</b>	FZL-PAR38-02-WW-22TDH / FZL-PAR38-02-CW-22TDH	FZL-PAR38-02-WW-22TDL / FZL-PAR38-02-CW-22TDL
<b>Input Voltage (V)</b>	AC 220 – 240V (TriAC dimmable)	AC 100 – 120V (TriAC dimmable)

## FZL-PAR38-03 Series

22W

- Luminous Flux (lm): 1300 (±10%) with 3000K / 1550 (±10%) with 6000K
- Power Consumption (W): 22
- LED: Cree
- CCT (K): 3000K (WW) / 6000K (CW)
- Lifetime (hrs): >35000
- Beam Angle: Clear Cover – 25° / 40° / 60°  
Frosted cover – 120°
- Socket: E26 / E27
- Net Weight (kgs): 0.505 (±10%)
- Switching Dimmable Function  
(4 steps: 100%/ 50%/ 25%/ 12%)

<b>Model</b>	FZL-PAR38-03-WW-22 / FZL-PAR38-03-CW-22	FZL-PAR38-03-WW-22SD / FZL-PAR38-03-CW-22SD
<b>Input Voltage (V)</b>	AC 90 – 264V (Non-dimmable)	AC 90 – 264V (Switching Dimmable)
<b>Model</b>	FZL-PAR38-03-WW-22TDH / FZL-PAR38-03-CW-22TDH	FZL-PAR38-03-WW-22TDL / FZL-PAR38-03-CW-22TDL
<b>Input Voltage (V)</b>	AC 220 – 240V (TriAC dimmable)	AC 100 – 120V (TriAC dimmable)



# Downlight



CE FC

## FZL-DL-02-00 Series

• Ceiling drill hole:  68 ~ 75mm

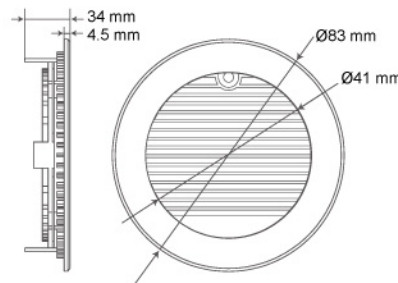

## FZL-DL-03-00 Series

• Ceiling drill hole:  90 ~ 95mm

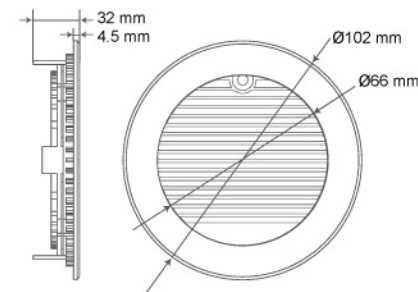

5W

### FZL-DL02-00 Series

- Luminous Flux (lm): 210 (±10%) with 3000K / 250 (±10%) with 4000K / 300 (±10%) with 6000K
- Power Consumption (W): 4.5
- LED: **Liteon**
- CCT (K): 3000K (WW) / 4000K (NW) / 6000K (CW)
- Lifetime (hrs): >35000
- Beam Angle: 120°
- Net Weight (kgs): 0.17 (±10%) with driver

Model	FZL-DL02-00-WW-05 FZL-DL02-00-NW-05 FZL-DL02-00-CW-05	FZL-DL02-00-WW-05TDH FZL-DL02-00-NW-05TDH FZL-DL02-00-CW-05TDH	FZL-DL02-00-WW-05TDL FZL-DL02-00-NW-05TDL FZL-DL02-00-CW-05TDL
Input Voltage (V)	AC 100 – 240V (Non-dimmable)	AC 220 – 240V (TriAC dimmable)	AC 100 – 120V (TriAC dimmable)

8W

### FZL-DL03-00 Series

- Luminous Flux (lm): 330 (±10%) with 3000K / 400 (±10%) with 4000K / 480 (±10%) with 6000K
- Power Consumption (W): 8
- LED: **Liteon**
- CCT (K): 3000K (WW) / 4000K (NW) / 6000K (CW)
- Lifetime (hrs): >35000
- Beam Angle: 120°
- Net Weight (kgs): 0.38 (±10%) with driver

Model	FZL-DL03-00-WW-08 FZL-DL03-00-NW-08 FZL-DL03-00-CW-08	FZL-DL03-00-WW-08TDH FZL-DL03-00-NW-08TDH FZL-DL03-00-CW-08TDH	FZL-DL03-00-WW-08TDL FZL-DL03-00-NW-08TDL FZL-DL03-00-CW-08TDL
Input Voltage (V)	AC 100 – 240V (Non-dimmable)	AC 220 – 240V (TriAC dimmable)	AC 100 – 120V (TriAC dimmable)

# Downlight

9W

## FZL-DL04-00 Series

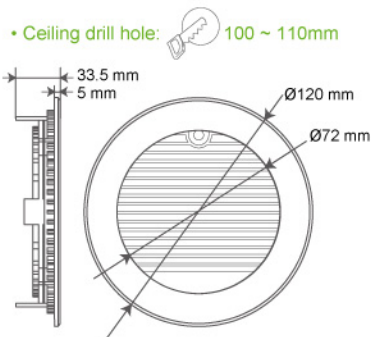

- Luminous Flux (lm): 400 (±10%) with 3000K / 470 (±10%) with 4000K / 560 (±10%) with 6000K
- Power Consumption (W): 9
- LED: Liteon
- CCT (K): 3000K (WW) / 4000K (NW) / 6000K (CW)
- Lifetime (hrs): >35000
- Beam Angle: 120°
- Net Weight (kgs): 0.48 (±10%) with driver

Model	FZL-DL04-00-WW-09 FZL-DL04-00-NW-09 FZL-DL04-00-CW-09	FZL-DL04-00-WW-09TDH FZL-DL04-00-NW-09TDH FZL-DL04-00-CW-09TDH	FZL-DL04-00-WW-09TDL FZL-DL04-00-NW-09TDL FZL-DL04-00-CW-09TDL
Input Voltage (V)	AC 100 – 240V (Non-dimmable)	AC 220 – 240V (TriAC dimmable)	AC 100 – 120V (TriAC dimmable)

12W

## FZL-DL06-00 Series

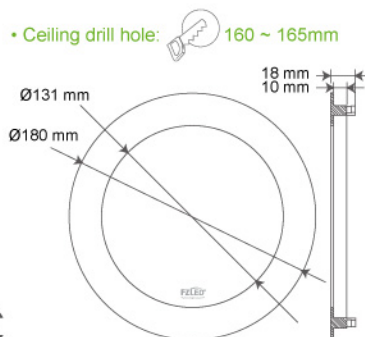

- Luminous Flux (lm): 600 (±10%) with 3000K / 620 (±10%) with 4000K / 750 (±10%) with 6000K
- Power Consumption (W): 12
- LED: Liteon
- CCT (K): 3000K (WW) / 4000K (NW) / 6000K (CW)
- Lifetime (hrs): >35000
- Beam Angle: 120°
- Net Weight (kgs): 0.46 (±10%) with driver

Model	FZL-DL06-00-WW-12 FZL-DL06-00-NW-12 FZL-DL06-00-CW-12	FZL-DL06-00-WW-12TDH FZL-DL06-00-NW-12TDH FZL-DL06-00-CW-12TDH	FZL-DL06-00-WW-12TDL FZL-DL06-00-NW-12TDL FZL-DL06-00-CW-12TDL
Input Voltage (V)	AC 100 – 240V (Non-dimmable)	AC 220 – 240V (TriAC dimmable)	AC 100 – 120V (TriAC dimmable)

# Downlight



## FZL-DL08-00 Series

• Ceiling drill hole:  220 ~ 230mm

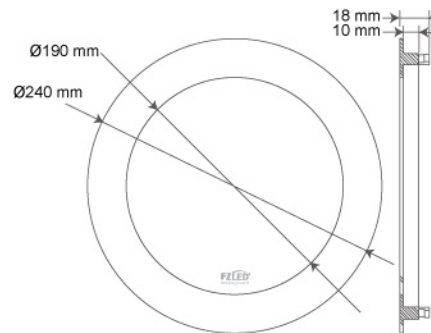

## FZL-DL10-00 Series

• Ceiling drill hole:  280 ~ 290mm

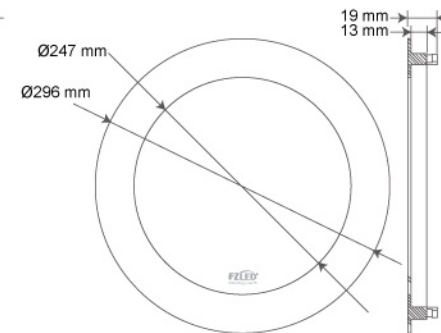

22W

### FZL-DL08-00 Series

- Luminous Flux (lm): 1150 (±10%) with 3000K / 1200 (±10%) with 4000K / 1400 (±10%) with 6000K
- Power Consumption (W): 22
- LED: **Liteon**
- CCT (K): 3000K (WW) / 4000K (NW) / 6000K (CW)
- Lifetime (hrs): >35000
- Beam Angle: 120°
- Net Weight (kgs): 0.66 (±10%) with driver

Model	FZL-DL08-00-WW-22 FZL-DL08-00-NW-22 FZL-DL08-00-CW-22	FZL-DL08-00-WW-22TDH FZL-DL08-00-NW-22TDH FZL-DL08-00-CW-22TDH	FZL-DL08-00-WW-22TDL FZL-DL08-00-NW-22TDL FZL-DL08-00-CW-22TDL
Input Voltage (V)	AC 100 – 240V (Non-dimmable)	AC 220 – 240V (TriAC dimmable)	AC 100 – 120V (TriAC dimmable)

28W

### FZL-DL10-00 Series

- Luminous Flux (lm): 1500 (±10%) with 3000K / 1600 (±10%) with 4000K / 1800 (±10%) with 6000K
- Power Consumption (W): 28
- LED: **Liteon**
- CCT (K): 3000K (WW) / 4000K (NW) / 6000K (CW)
- Lifetime (hrs): >35000
- Beam Angle: 120°
- Net Weight (kgs): 1.2 (±10%) with driver

Model	FZL-DL10-00-WW-28 FZL-DL10-00-NW-28 FZL-DL10-00-CW-28	FZL-DL10-00-WW-28TDH FZL-DL10-00-NW-28TDH FZL-DL10-00-CW-28TDH	FZL-DL10-00-WW-28TDL FZL-DL10-00-NW-28TDL FZL-DL10-00-CW-28TDL
Input Voltage (V)	AC 100 – 240V (Non-dimmable)	AC 220 – 240V (TriAC dimmable)	AC 100 – 120V (TriAC dimmable)

# Downlight



CE FC

## FZL-DL-06-01 Series

• Ceiling drill hole:  140 ~ 150mm

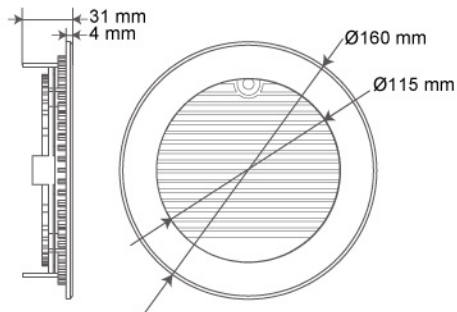

## FZL-DL-08-01 Series

• Ceiling drill hole:  180 ~ 185mm

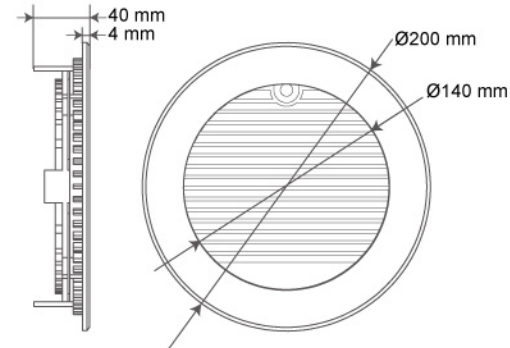

12W

## FZL-DL06-01 Series

- Luminous Flux (lm): 600 (±10%) with 3000K / 620 (±10%) with 4000K / 750 (±10%) with 6000K
- Power Consumption (W): 12
- LED: **Liteon**
- CCT (K): 3000K (WW) / 4000K (NW) / 6000K (CW)
- Lifetime (hrs): >35000
- Beam Angle: 120°
- Net Weight (kgs): 0.48 (±10%) with driver

Model	FZL-DL06-01-WW-12 FZL-DL06-01-NW-12 FZL-DL06-01-CW-12	FZL-DL06-01-WW-12TDH FZL-DL06-01-NW-12TDH FZL-DL06-01-CW-12TDH	FZL-DL06-01-WW-12TDL FZL-DL06-01-NW-12TDL FZL-DL06-01-CW-12TDL
Input Voltage (V)	AC 100 – 240V (Non-dimmable)	AC 220 – 240V (TriAC dimmable)	AC 100 – 120V (TriAC dimmable)

22W

## FZL-DL08-01 Series

- Luminous Flux (lm): 1150 (±10%) with 3000K / 1200 (±10%) with 4000K / 1400 (±10%) with 6000K
- Power Consumption (W): 22
- LED: **Liteon**
- CCT (K): 3000K (WW) / 4000K (NW) / 6000K (CW)
- Lifetime (hrs): >35000
- Beam Angle: 120°
- Net Weight (kgs): 0.64 (±10%) with driver

Model	FZL-DL08-01-WW-22 FZL-DL08-01-NW-22 FZL-DL08-01-CW-22	FZL-DL08-01-WW-22TDH FZL-DL08-01-NW-22TDH FZL-DL08-01-CW-22TDH	FZL-DL08-01-WW-22TDL FZL-DL08-01-NW-22TDL FZL-DL08-01-CW-22TDL
Input Voltage (V)	AC 100 – 240V (Non-dimmable)	AC 220 – 240V (TriAC dimmable)	AC 100 – 120V (TriAC dimmable)

# Panel Light



22W

## FZL-PL30-00-22 Series (300 x 300 mm)

- Luminous Flux (lm): 1200 (±10%) with 3000K / 1300 (±10%) with 4000K / 1500 (±10%) with 6000K
- Power Consumption (W): 22
- LED: **Liteon**
- CCT (K): 3000K (WW) / 4000K (NW) / 6000K (CW)
- Lifetime (hrs): >35000
- Beam Angle: 120°
- Net Weight (kgs): 2.5 (±10%) with driver

Model	FZL-PL30-00-WW-22	FZL-PL30-00-WW-22TDH
	FZL-PL30-00-NW-22	FZL-PL30-00-NW-22TDH
	FZL-PL30-00-CW-22	FZL-PL30-00-CW-22TDH
Input Voltage (V)	AC 100 – 240V (Non-dimmable)	AC 220 – 240V (TriAC dimmable)

Model	FZL-PL30-00-WW-22TDL
	FZL-PL30-00-NW-22TDL
	FZL-PL30-00-CW-22TDL
Input Voltage (V)	AC 100 – 120V (TriAC dimmable)

52W

## FZL-PL60-00-52 Series (600 x 600 mm)

- Luminous Flux (lm): 2900 (±10%) with 3000K / 3050 (±10%) with 4000K / 4200 (±10%) with 6000K
- Power Consumption (W): 52
- LED: **Liteon**
- CCT (K): 3000K (WW) / 4000K (NW) / 6000K (CW)
- Lifetime (hrs): >35000
- Beam Angle: 120°
- Net Weight (kgs): 5 (±10%) with driver

Model	FZL-PL60-00-WW-52	FZL-PL60-00-WW-52TDH	FZL-PL60-00-WW-52TDL
	FZL-PL60-00-NW-52	FZL-PL60-00-NW-52TDH	FZL-PL60-00-NW-52TDL
	FZL-PL60-00-CW-52	FZL-PL60-00-CW-52TDH	FZL-PL60-00-CW-52TDL
Input Voltage (V)	AC 100 – 240V (Non-dimmable)	AC 220 – 240V (TriAC dimmable)	AC 100 – 120V (TriAC dimmable)

52W

## FZL-PL120-00-52 Series (1200 x 300 mm)

- Luminous Flux (lm): 2900 (±10%) with 3000K / 3050 (±10%) with 4000K / 4200 (±10%) with 6000K
- Power Consumption (W): 52
- LED: **Liteon**
- CCT (K): 3000K (WW) / 4000K (NW) / 6000K (CW)
- Lifetime (hrs): >35000
- Beam Angle: 120°
- Net Weight (kgs): 5.2 (±10%) with driver

Model	FZL-PL120-00-WW-52	FZL-PL120-00-WW-52TDH	FZL-PL120-00-WW-52TDL
	FZL-PL120-00-NW-52	FZL-PL120-00-NW-52TDH	FZL-PL120-00-NW-52TDL
	FZL-PL120-00-CW-52	FZL-PL120-00-CW-52TDH	FZL-PL120-00-CW-52TDL
Input Voltage (V)	AC 100 – 240V (Non-dimmable)	AC 220 – 240V (TriAC dimmable)	AC 100 – 120V (TriAC dimmable)

FZL-PL30-00-22 Series

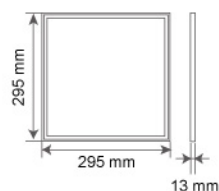

FZL-PL60-00-52 Series

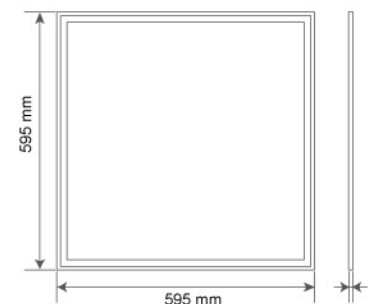

FZL-PL120-00-52 Series

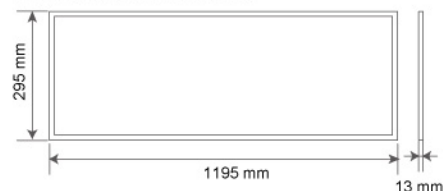

# Panel Light



28W

## FZL-PL30-01-28 Series (300 x 300 mm)

- Luminous Flux (lm): 1400 (±10%) with 3000K / 1550 (±10%) with 4000K / 1800 (±10%) with 6000K
- Power Consumption (W): 28
- LED: Liteon
- CCT (K): 3000K (WW) / 4000K (NW) / 6000K (CW)
- Lifetime (hrs): >35000
- Beam Angle: 120°
- Net Weight (kgs): 2.2 (±10%) with driver

Model	FZL-PL30-01-WW-28	FZL-PL30-01-WW-28TDH	FZL-PL30-01-WW-28TDL
	FZL-PL30-01-NW-28	FZL-PL30-01-NW-28TDH	FZL-PL30-01-NW-28TDL
	FZL-PL30-01-CW-28	FZL-PL30-01-CW-28TDH	FZL-PL30-01-CW-28TDL
Input Voltage (V)	AC 100 – 240V (Non-dimmable)	AC 220 – 240V (TriAC dimmable)	AC 100 – 120V (TriAC dimmable)

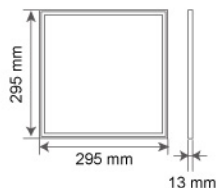

42W

## FZL-PL60-01-42 Series (600 x 600 mm)

- Luminous Flux (lm): 2400 (±10%) with 3000K / 2500 (±10%) with 4000K / 3400 (±10%) with 6000K
- Power Consumption (W): 42
- LED: Liteon
- CCT (K): 3000K (WW) / 4000K (NW) / 6000K (CW)
- Lifetime (hrs): >35000
- Beam Angle: 120°
- Net Weight (kgs): 4.5 (±10%) with driver

Model	FZL-PL60-01-WW-42	FZL-PL60-01-WW-42TDH	FZL-PL60-01-WW-42TDL
	FZL-PL60-01-NW-42	FZL-PL60-01-NW-42TDH	FZL-PL60-01-NW-42TDL
	FZL-PL60-01-CW-42	FZL-PL60-01-CW-42TDH	FZL-PL60-01-CW-42TDL
Input Voltage (V)	AC 100 – 240V (Non-dimmable)	AC 220 – 240V (TriAC dimmable)	AC 100 – 120V (TriAC dimmable)

52W

## FZL-PL60-01-52 Series (600 x 600 mm)

- Luminous Flux (lm): 2900 (±10%) with 3000K / 3050 (±10%) with 4000K / 4200 (±10%) with 6000K
- Power Consumption (W): 52
- LED: Liteon
- CCT (K): 3000K (WW) / 4000K (NW) / 6000K (CW)
- Lifetime (hrs): >35000
- Beam Angle: 120°
- Net Weight (kgs): 4.5 (±10%) with driver

Model	FZL-PL60-01-WW-52	FZL-PL60-01-WW-52TDH	FZL-PL60-01-WW-52TDL
	FZL-PL60-01-NW-52	FZL-PL60-01-NW-52TDH	FZL-PL60-01-NW-52TDL
	FZL-PL60-01-CW-52	FZL-PL60-01-CW-52TDH	FZL-PL60-01-CW-52TDL
Input Voltage (V)	AC 100 – 240V (Non-dimmable)	AC 220 – 240V (TriAC dimmable)	AC 100 – 120V (TriAC dimmable)

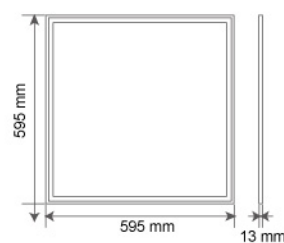

FZL-PL60-01L-42 Series  
FZL-PL60-01L-52 Series

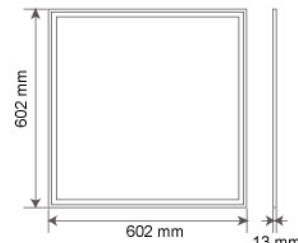

FZL-PL60-01M-42 Series  
FZL-PL60-01M-52 Series

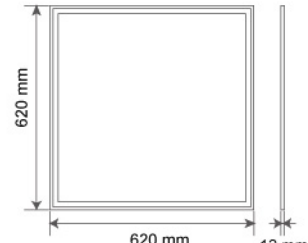

FZL-PL60-01H-42 Series  
FZL-PL60-01H-52 Series

# Panel Light



FZL-PL120-01-42 Series / FZL-PL120-01-52 Series

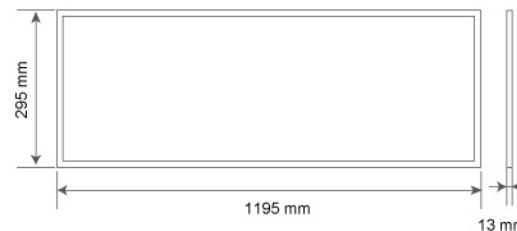

42W

## FZL-PL120-01-42 Series (1200 x 300 mm)

- Luminous Flux (lm): 2400 (±10%) with 3000K / 2500 (±10%) with 4000K / 3400 (±10%) with 6000K
- Power Consumption (W): 42
- LED: Liteon
- CCT (K): 3000K (WW) / 4000K (NW) / 6000K (CW)
- Lifetime (hrs): >35000
- Beam Angle: 120°
- Net Weight (kgs): 4.7 (±10%) with driver

Model	FZL-PL120-00-WW-42 FZL-PL120-00-NW-42 FZL-PL120-00-CW-42	FZL-PL120-00-WW-42TDH FZL-PL120-00-NW-42TDH FZL-PL120-00-CW-42TDH	FZL-PL120-00-WW-42TDL FZL-PL120-00-NW-42TDL FZL-PL120-00-CW-42TDL
Input Voltage (V)	AC 100 – 240V (Non-dimmable)	AC 220 – 240V (TriAC dimmable)	AC 100 – 120V (TriAC dimmable)

52W

## FZL-PL120-01-52 Series (1200 x 300 mm)

- Luminous Flux (lm): 2900 (±10%) with 3000K / 3050 (±10%) with 4000K / 4200 (±10%) with 6000K
- Power Consumption (W): 52
- LED: Liteon
- CCT (K): 3000K (WW) / 4000K (NW) / 6000K (CW)
- Lifetime (hrs): >35000
- Beam Angle: 120°
- Net Weight (kgs): 4.7 (±10%) with driver

Model	FZL-PL120-00-WW-52 FZL-PL120-00-NW-52 FZL-PL120-00-CW-52	FZL-PL120-00-WW-52TDH FZL-PL120-00-NW-52TDH FZL-PL120-00-CW-52TDH	FZL-PL120-00-WW-52TDL FZL-PL120-00-NW-52TDL FZL-PL120-00-CW-52TDL
Input Voltage (V)	AC 100 – 240V (Non-dimmable)	AC 220 – 240V (TriAC dimmable)	AC 100 – 120V (TriAC dimmable)

# T8

## Tube Light

### FZL-T8-05L Series

[2 Feet – Type 1]



[2 Feet – Type 2]

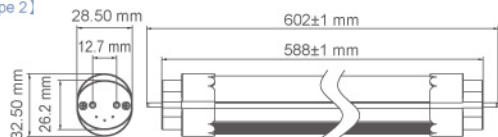

[4 Feet] :18W / 20W

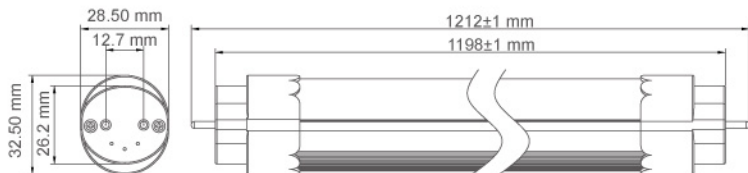

10W

- Power Consumption (W): 10
- LED: 3528
- Input Voltage (V): AC 100 – 240V
- Lifetime (hrs): >35000
- Beam Angle: 120°
- Socket: G13
- Net Weight (kgs): 0.240 (±10%)
- Dimmable: Non-dimmable

Model	FZL-T8-05L-WW-10	FZL-T8-05L-NW-10	FZL-T8-05L-CW-10
CCT (K)	3000 (±10%)	4100 (±10%)	6000 (±10%)
Luminous Flux (lm)	650 (±10%)	710 (±10%)	850 (±10%)
Dimension (mm)	2 Feet – Type 1: Ø32.5 X 580 / 2 Feet – Type 2: Ø32.5 X 600		

18W

- Power Consumption (W): 18
- LED: 3528
- Input Voltage (V): AC 100 – 240V
- Lifetime (hrs): >35000
- Beam Angle: 120°
- Socket: G13
- Net Weight (kgs): 0.380 (±10%)
- Dimmable: Non-dimmable

Model	FZL-T8-05L-WW-18	FZL-T8-05L-NW-18	FZL-T8-05L-CW-18
CCT (K)	3000 (±10%)	4100 (±10%)	6000 (±10%)
Luminous Flux (lm)	1100 (±10%)	1250(±10%)	1500 (±10%)
Dimension (mm)	4 Feet: Ø32.5 X 1198		

20W

- Power Consumption (W): 20
- LED: 3528
- Input Voltage (V): AC 100 – 240V
- Lifetime (hrs): >35000
- Beam Angle: 120°
- Socket: G13
- Net Weight (kgs): 0.400 (±10%)
- Dimmable: Non-dimmable

Model	FZL-T8-05L-WW-20	FZL-T8-05L-NW-20	FZL-T8-05L-CW-20
CCT (K)	3000 (±10%)	4100 (±10%)	6000 (±10%)
Luminous Flux (lm)	1300 (±10%)	1450 (±10%)	1700 (±10%)
Dimension (mm)	4 Feet – Type 1: Ø32.5 X 1198		





# T8

## Tube Light

### FZL-T8-06L Series



[2 Feet – Type 1]



[2 Feet – Type 2]

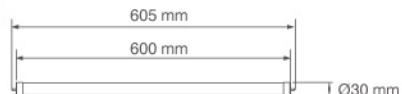

[4 Feet]



[5 Feet]

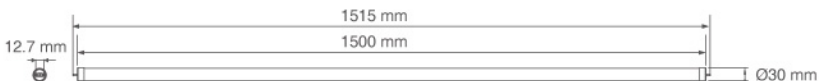

28W

- Power Consumption (W): 28
- LED: Liteon
- Lifetime (hrs): >35000
- Socket: G13
- Dimmable: Non-dimmable

- Housing: Plastic + Aluminum
- Input Voltage (V): AC 100 – 240V
- Beam Angle: 120°
- Net Weight (kgs): 0.530 (±10%)

Model	FZL-T8-06L-WW-28	FZL-T8-06L-NW-28	FZL-T8-06L-CW-28
CCT (K)	3000	4000	6000
Luminous Flux (lm)	2020 (±10%)	2300 (±10%)	2800 (±10%)
Dimension (mm)	5 Feet – Type 1: Ø30 X 1500		

12W

- Power Consumption (W): 12
- LED: Liteon
- Lifetime (hrs): >35000
- Socket: G13
- Dimmable: Non-dimmable

- Housing: Plastic + Aluminum
- Input Voltage (V): AC 100 – 240V
- Beam Angle: 120°
- Net Weight (kgs): 0.210 (±10%)

Model	FZL-T8-06L-WW-12	FZL-T8-06L-NW-12	FZL-T8-06L-CW-12
CCT (K)	3000	4000	6000
Luminous Flux (lm)	710 (±10%)	850 (±10%)	1000 (±10%)
Dimension (mm)	2 Feet – Type 1: Ø30 X 580 / 2 Feet – Type 2: Ø30 X 600		

44W

- Power Consumption (W): 44
- LED: Liteon
- Lifetime (hrs): >35000
- Socket: G13 / R17D / FA8
- Dimmable: Non-dimmable

- Housing: Plastic + Aluminum
- Input Voltage (V): AC 90 – 277V
- Beam Angle: 120°
- Net Weight (kgs): 0.90 (±10%)

Model	FZL-T8-06L-WW-45	FZL-T8-06L-NW-45	FZL-T8-06L-CW-45
CCT (K)	3000	4000	6000
Luminous Flux (lm)	3200 (±10%)	3600 (±10%)	4400 (±10%)

22W

- Power Consumption (W): 22
- LED: Liteon
- Lifetime (hrs): >35000
- Socket: G13
- Dimmable: Non-dimmable

- Housing: Plastic + Aluminum
- Input Voltage (V): AC 100 – 240V
- Beam Angle: 120°
- Net Weight (kgs): 0.432 (±10%)

Model	FZL-T8-06L-WW-22	FZL-T8-06L-NW-22	FZL-T8-06L-CW-22
CCT (K)	3000	4000	6000
Luminous Flux (lm)	1600 (±10%)	1800 (±10%)	2200 (±10%)
Dimension (mm)	4 Feet: Ø30 X 1200		

[8 Feet] G13



[8 Feet] R17D



[8 Feet] FA8



# T8

## Tube Light

### FZL-T8-07 Series

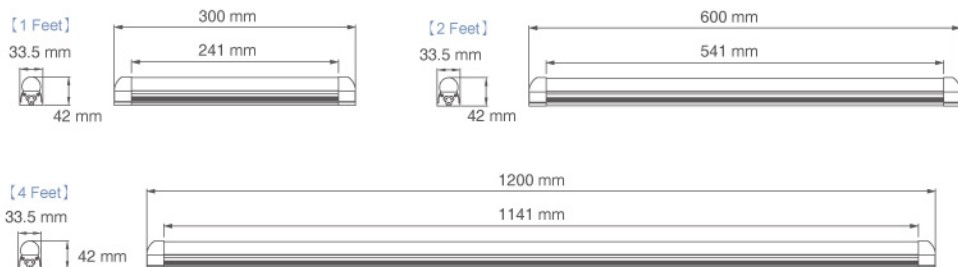

### Accessories

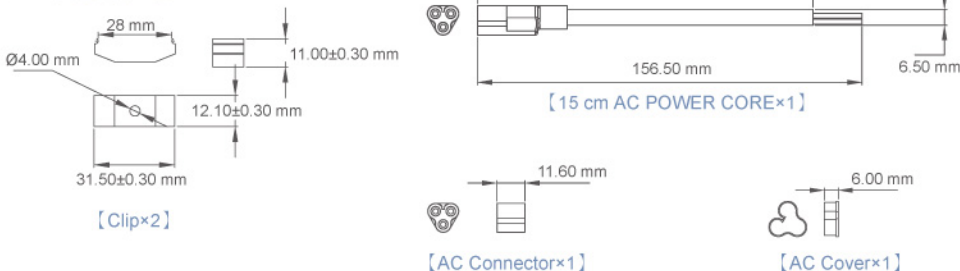

### 6W

- Power Consumption (W): 6 (±10%)
- LED: Liteon
- Input Voltage (V): AC 100 - 240V
- Lifetime (hrs): >35000
- Beam Angle: 120°
- Socket: 3 Pin
- Net Weight (kgs): 0.150 (±10%)
- Dimmable: Non-dimmable

Model	FZL-T8-07-WW-06	FZL-T8-07-NW-06	FZL-T8-07-CW-06
CCT (K)	3000	4000	6000
Luminous Flux (lm)	355 (±10%)	425 (±10%)	500 (±10%)
Dimension (mm)	1 foot – Ø33.5×42×300		

### 12W

- Power Consumption (W): 12 (±10%)
- LED: Liteon
- Input Voltage (V): AC 100 - 240V
- Lifetime (hrs): >35000
- Beam Angle: 120°
- Socket: 3 Pin
- Net Weight (kgs): 0.250 (±10%)
- Dimmable: Non-dimmable

Model	FZL-T8-07-WW-12	FZL-T8-07-NW-12	FZL-T8-07-CW-12
CCT (K)	3000	4000	6000
Luminous Flux (lm)	710 (±10%)	850 (±10%)	1000 (±10%)
Dimension (mm)	2 feet – Ø33.5×42×600		

### 22W

- Power Consumption (W): 22 (±10%)
- LED: Liteon
- Input Voltage (V): AC 100 - 240V
- Lifetime (hrs): >35000
- Beam Angle: 120°
- Socket: 3 Pin
- Net Weight (kgs): 0.480 (±10%)
- Dimmable: Non-dimmable

Model	FZL-T8-07-WW-22	FZL-T8-07-NW-22	FZL-T8-07-CW-22
CCT (K)	3000	4000	6000
Luminous Flux (lm)	1600 (±10%)	1800 (±10%)	2200 (±10%)
Dimension (mm)	4 feet – Ø33.5×42×1200		

# FloodLight

## FZL-FL Series

CE FC IP65

[FZL-FL12-00-12]

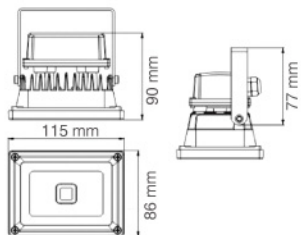

[FZL-FL35-00-35]

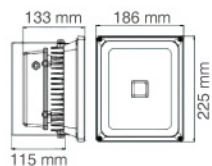

[FZL-FL60-00-60]

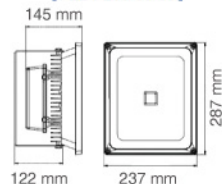

[FZL-FL110-00-110]

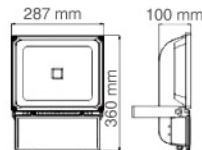

12W

- Power Consumption (W): 12 (±10%)
- LED: Epistar
- Input Voltage (V): AC 100 - 240V
- Lifetime (hrs): >35000
- Beam Angle: 120°
- IP65
- Net Weight (kgs): 0.50 (±10%)
- Dimmable: Non-dimmable

Model	FZL-FL12-00-WW-12	FZL-FL12-00-CW-12
CCT (K)	3000 (±10%)	6000 (±10%)
Luminous Flux (lm)	700 (±10%)	800 (±10%)

35W

- Power Consumption (W): 37 (±10%)
- LED: Epistar
- Input Voltage (V): AC 100 - 240V
- Lifetime (hrs): >35000
- Beam Angle: 120°
- IP65
- Net Weight (kgs): 2.3 (±10%)
- Dimmable: Non-dimmable

Model	FZL-FL35-00-WW-35	FZL-FL35-00-CW-35
CCT (K)	3000 (±10%)	6000 (±10%)
Luminous Flux (lm)	2200 (±10%)	2700 (±10%)

60W

- Power Consumption (W): 61 (±10%)
- LED: Epistar
- Input Voltage (V): AC 100 - 240V
- Lifetime (hrs): >35000
- Beam Angle: 120°
- IP65
- Net Weight (kgs): 3.5 (±10%)
- Dimmable: Non-dimmable

Model	FZL-FL60-00-WW-60	FZL-FL60-00-CW-60
CCT (K)	3000 (±10%)	6000 (±10%)
Luminous Flux (lm)	3700 (±10%)	4500 (±10%)

110W

- Power Consumption (W): 110 (±10%)
- LED: Epistar
- Input Voltage (V): AC 100 - 240V
- Lifetime (hrs): >35000
- Beam Angle: 120°
- IP65
- Net Weight (kgs): 8.0 (±10%)
- Dimmable: Non-dimmable

Model	FZL-FL110-00-WW-110	FZL-FL110-00-CW-110
CCT (K)	3000 (±10%)	6000 (±10%)
Luminous Flux (lm)	7500 (±10%)	9000 (±10%)

# LED Torch

## FZL-1310 Bike Torch



- Power consumption: 3W
- Input power: 3 x AAA battery (up to 10 hrs estimated run time when using fresh batteries)
- Operation temperature (for LED): -20 ~ +50 °C
- Net weight (included bracket): 0.160 (±10%) kgs
- Long lifetime: up to 50000 hours (LED)
- Focus Control: Focused / Spread
- The illumination: up to 100 - 200 m
- High brightness: up to 4800 lux at 1m
- Dimension: 30 (Dia) X 100 (L) mm
- Function: 100% / Flash

## FZL-2110 Portable Torch



- Power consumption: 1W
- Input power: 1 x AAA batteries (up to 10 hrs estimated run time when using fresh batteries)
- Operation temperature (for LED): -20 ~ +50 °C
- Net weight: 0.030 (±10%) kgs
- Long lifetime: up to 50000 hours (LED)
- The illumination: up to 50 m
- High brightness: up to 2400 lux at 1m
- Dimension: 16 (Dia) X 105 (L) mm
- IP54

## FZL-2200 Hiking Torch



- Power consumption: 3W
- Input power: 3 x AAA batteries (up to 22 hrs estimated run time when using fresh batteries)
- Operation temperature (for LED): -20 ~ +50 °C
- Net weight: 0.130 (±10%) kgs
- Long lifetime: up to 50000 hours (LED)
- The illumination: up to 100 - 200 m
- High brightness: up to 4800 lux at 1m
- Functions: 30% / 70% / 100% / SOS / Flash
- Dimension: 38 (Dia) X 26 X 144 (L) mm

## FZL-2301 Security Torch



- Power consumption: 3W
- Input power: 3 x D batteries (up to 40 hrs estimated run time when using fresh batteries)
- Operation temperature (for LED): -20 ~ +50 °C
- Net weight: 0.478 (±10%) kgs
- Long lifetime: up to 50000 hours (LED)
- The illumination: up to 100 - 200 m
- High brightness: up to 4800 lux at 1m
- Dimension: 55 (Dia) X 40 X 370 (L) mm

# LED Torch

## FZL-2300 Security Torch

- Power consumption: 3W
- Input power: 3 x D batteries (up to 40 hrs estimated run time when using fresh batteries)
- Operation temperature (for LED): -20 ~ +50 °C
- Net weight: 0.408 (±10%) kgs
- Long lifetime: up to 50000 hours (LED)
- The illumination: up to 100 - 200 m
- High brightness: up to 4800 lux at 1m
- Dimension: 55 (Dia) X 40 X 315 (L) mm



## FZL-2500 Water Proof Torch

- Power consumption: 3W
- Input power: 6 x AAA batteries (up to 15 hrs estimated run time when using fresh batteries)
- Operation temperature (for LED): -20 ~ +50 °C
- Net weight: 0.195 (±10%) kgs
- Long lifetime: up to 35000 hours (LED)
- The illumination: up to 100 m
- High brightness: up to 5100 lux at 1m
- Waterproof: up to 100 m
- IP68
- Dimension: 38 (Dia) X 32 X 160 (L) mm



## FZL-4200 Head Light

- Power consumption: 1W
- Input power: 3 x AA batteries (up to 25 hrs estimated run time when using fresh batteries)
- Operation temperature (for LED): -20 ~ +50 °C
- Functions: Push On/Off, flash, adjust up to 45 degree toward lower side
- Optic: using convex lens to focus light beam
- Net weight: 0.155 (±10%) kgs
- Long lifetime: up to 50000 hours (LED)
- The illumination: up to 50 - 100 m
- High brightness: up to 2400 lux at 1m



## FZL-3201 Flexible Work Light

- Power consumption: 3W
- Input power: 3 x AA batteries (up to 15 hrs estimated run time when using fresh batteries)
- Operation temperature (for LED): -20 ~ +50 °C
- Optic: using convex lens to focus light beam
- Net weight: 0.292 (±10%) kgs
- Long lifetime: up to 50000 hours (LED)
- The illumination: up to 100 - 200 m
- High brightness: up to 4800 lux at 1m
- Dimension: 35 (Dia) X 180 (L) mm



# LED Torch

## FZL-5100 Night Light Torch



- **Power consumption:** 3W (Torch) & 0.5W (Night light)
- **Input power:** 3 x AAA batteries (up to 10hrs estimated run time when using fresh batteries)
- **LED:** LG (Torch) & Lextar SMD (Night light)
- **Operation temperature (for LED):** 0 ~ +50 °C
- **CCT:** 6500K (Torch) and 3000K (Night Light)
- **Net weight:** 0.132 (±10%) kgs
- **Long lifetime:** up to 30000 hours (LED)
- **Dimension:** 40 (Dia) X 140 (L) mm
- **IP64 Waterproof**
- **Function:** All lights up 100% On/Off (torch & night light), torch 100%, torch 50%, torch flash, night light on/off

# Aqua Light

## FZL-6100

- **Power consumption:** 5W
- **LED light options:**
  1. Nature (Green) – for all ornamental fish
  2. Marine Day (Brown) – for marine fish, marine invertebrates, and African Cichlids.
  3. Tropic (Yellow) – for plants, shrimp, and tropical fish
- **Input power:** 12V AC/DC 100-240V, 50/60Hz
- **Net weight:** 0.173 (+-10%) kgs
- **Long lifetime:** up to 35000 hours (LED)
- **CE, CNS, EMI, EMC approved**



FZ Group

**FZtech**<sup>®</sup>  
Ease up your life  
[www.FZtech.com.tw](http://www.FZtech.com.tw)

**FZLED**<sup>®</sup>  
Make Your Life Bright  
[www.FZled.com.tw](http://www.FZled.com.tw)

### Taiwan Headquarter

地址:新北市中和區235板南路498號7樓之3

Address: 7F-3, No.498, BanNan Rd., ZhongHe Dist.,  
New Taipei City, Taiwan, 235, R.O.C

Tel: +886-2-2228-7885

Fax: +886-2-2228-8938

E-mail: [sales@fztech.com.tw](mailto:sales@fztech.com.tw)

### Singapore Branch

**VFZLED Pte Ltd**

Address: Block 1090 Lower Delta Road, #07-07  
Singapore 169201

Tel: +65 97945790

E-mail: [sales-SGP@fztech.com.tw](mailto:sales-SGP@fztech.com.tw)

### Thailand Branch

Address: 18/75 Raktaya Town, T. Klong sourn ploo,  
Ayutthaya. Thailand (13000)

Tel: +66 89411 5900 / +66 84520 2585

E-mail: [sales-thailand@fztech.com.tw](mailto:sales-thailand@fztech.com.tw)

Website: [www.fzled-thai.com](http://www.fzled-thai.com)

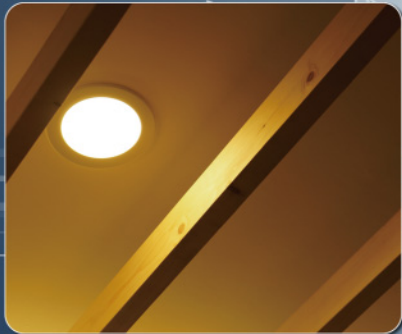

© 2014 FZtech Inc. All Rights Reserved. All specifications are subject to change without notice.  
For more information, please visit our official website: [www.FZLED.com.tw](http://www.FZLED.com.tw)

